

à billes de l'autre main. Soulevez la chaîne à billes hors de la rainure de verrouillage des billes et faites glisser le dispositif de tension jusqu'au bas de la boucle de la chaîne.

Tirez le dispositif de tension vers le bas jusqu'à ce que la chaîne à billes soit complètement tendue (le piston sera en haut), puis déplacez le dispositif de tension vers le haut d'environ 1/8".

Marquez les emplacements des vis sur le mur ou le cadre de la fenêtre avec un crayon.

**Montage intérieur:** en cas de montage dans du bois, pré-percez les trous de vis, puis installez le dispositif de tension à l'aide des vis à tête Phillips de 1 pouce fournies.

Si vous ne le fixez pas dans le bois, utilisez des ancrages appropriés au substrat et suivez les instructions du fabricant des ancrages.

**Montage extérieur:** déplacez le dispositif de tension vers le bas de la chaîne comme indiqué ci-dessus. Appuyez ensuite le dispositif de tension sur les poteaux du support de montage. Installez soigneusement les vis à tête Phillips 3/8» fournies à travers le dispositif de tension dans le support de montage à l'aide d'un tournevis cruciforme (NE PAS TROP SERRER !). Tirez le dispositif de tension vers le bas comme indiqué ci-dessus et marquez au crayon la position du support de montage extérieur. Détachez maintenant le dispositif de tension du support, marquez au crayon les emplacements des vis du support et fixez-le à l'aide des vis de 1», puis rattachiez le dispositif de tension au support.

#### **Fonctionnement du store**

L'exposition limitée du cordon est une mesure de sécurité requise. Par conséquent, le cordon doit être tiré plusieurs fois pour soulever ou abaisser le store. Soyez patient, tirez le cordon lentement et doucement pour prolonger la durée de vie du store.

**STRANGULATION HAZARD** — Young children can be strangled by cords. Immediately remove this product if a cord longer than 22 cm or a loop exceeding 44 cm around becomes accessible.

**RISQUE D'ÉTRANGLEMENT** — Les enfants en bas âge peuvent s'étrangler avec des cordes. Enlevez immédiatement ce produit si une corde mesurant plus de 22 cm devient accessible ou si le contour d'une boucle de plus de 44 cm devient accessible.

## SUPPLEMENTARY INSTALLATION INSTRUCTIONS FOR CUSTOMERS IN CANADA

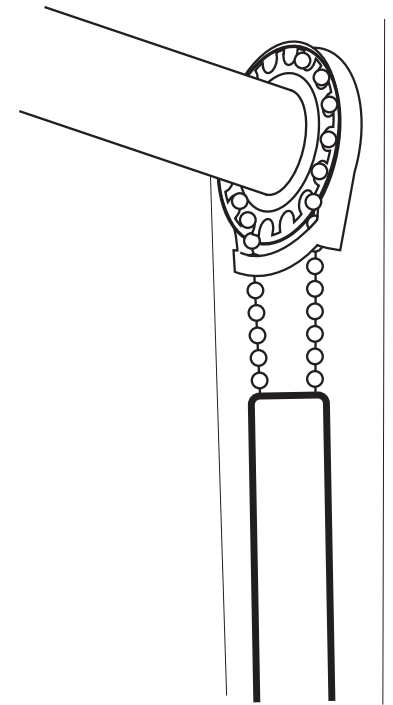

#### **Installing Shades with a Chain Cover**

Your new shade includes a dedicated lift cord/chain cover that allows for no more than 22cm (8") of lift cord to be exposed at any time. The cover is pre-attached to the beaded chain lift cord.

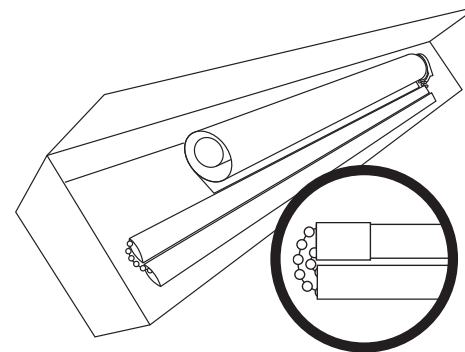

The cover for larger shades will be in two sections which are separated when the shade is packaged for shipment and thus must be joined together when the shade is

installed. See complete instructions below:

**Step 1** – Carefully remove the protective bubble wrap from both ends of the shade. Do not remove the bubble wrap at the center of the shade until the shade is fully installed. Unwrap the Bead Chain and Tension Device being certain not to damage the chain. Cut and remove the zip-tie.

**Step 2** – Attach the shade using the detailed instructions that came with the shade. Allow the chain, chain cover and tension device to hang freely when mounting the shade.

**Step 3** – If the Chain Cover is in two sections, attach the sections as illustrated.

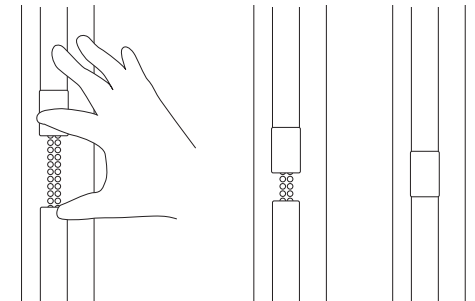

*Slide the bottom section of the Chain Cover into the Connector that is pre-attached to the upper section*

**Step 4** – Attach the Tension Device

**IMPORTANT** – The Tension Device must be attached as detailed in these instructions for your shade to function properly.

If possible, have a helper hold the Chain Cover up and out of the way when installing the Tension Device.

While holding the tension device in one hand, pull the plunger away from the bead chain with the other hand. Lift the bead chain out of the bead locking groove and slide the tension device to the bottom of the chain loop.

Pull the tension device down until the bead chain is fully tensioned (plunger will be at

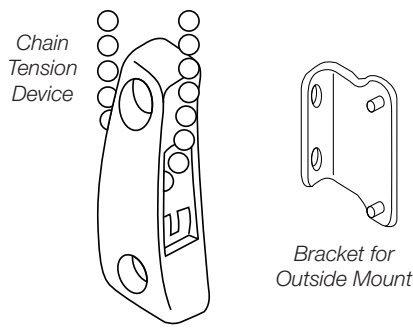

mark the screw locations for the bracket and attach it using the 1" screws, and then reattach the tension device to the bracket.

### **Operating the Shade**

The limited cord exposure is a required safety measure. As a result, the cord must be pulled many times to lift or lower the shade. Be patient, pull the cord slowly and smoothly to prolong the life of the shade.

the top) and then move the tension device up approximately 1/8".

Mark the screw locations on the wall or window frame with a pencil.

**Inside Mount:** If mounting into wood, predrill screw holes and then install the tension device using the 1" Phillips head screws provided.

If not securing into wood, use appropriate anchors for the substrate and follow the anchor manufacturer's instructions.

**Outside Mount:** Move the tension Device to the bottom of the chain as noted above. Then press the tension device onto the mounting bracket posts. Carefully install the 3/8" Phillips head screws provided through the tension device into the mounting bracket using a Phillips head screwdriver (DO NOT OVER-TIGHTEN!). Pull the tension device down as noted above and pencil mark the position of the outside mount bracket. Now detach the tension device from the bracket, pencil

**STRANGULATION HAZARD** — Young children can be strangled by cords. Immediately remove this product if a cord longer than 22 cm or a loop exceeding 44 cm around becomes accessible.

**RISQUE D'ÉTRANGLEMENT** — Les enfants en bas âge peuvent s'étrangler avec des cordes. Enlevez immédiatement ce produit si une corde mesurant plus de 22 cm devient accessible ou si le contour d'une boucle de plus de 44 cm devient accessible.

## **INSTRUCTIONS D'INSTALLATION SUPPLÉMENTAIRES POUR LES CLIENTS AU CANADA**

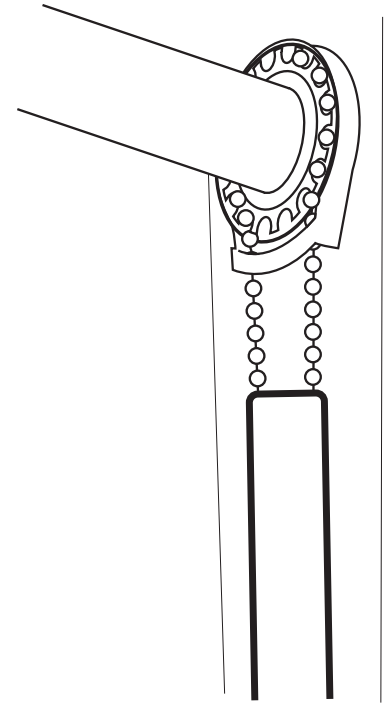

séparées lorsque le store est emballé pour l'expédition et doivent donc être assemblées lorsque le store est installé. Voir les instructions complètes ci-dessous :

**étape 1** – Retirez délicatement le film protecteur à bulles des deux extrémités du store. Ne retirez pas le papier bulle au centre du store tant que le store n'est pas complètement installé. Déballez la chaîne à billes et le dispositif de tension en vous assurant de ne pas endommager la chaîne. Coupez et retirez l'attache zippée.

**étape 2** – Fixez le store en suivant les instructions détaillées fournies avec le store. Laissez la chaîne, le couvercle de chaîne et le dispositif de tension pendre librement lors du montage du store.

**étape 3** – Si le couvre-chaîne est composé de deux sections, fixez les sections comme illustré.

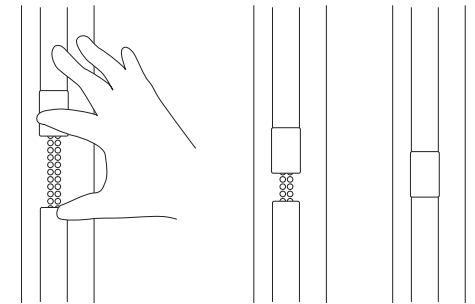

### **Installation de stores avec un couvre-chaîne**

Votre nouveau store comprend un couvre-cordon/chaîne de levage dédié qui permet d'exposer à tout moment un maximum de 22 cm (8") de cordon de levage. La housse est pré-attachée au cordon de levage à chaîne perlée.

Faites glisser la section inférieure du couvercle de chaîne dans le connecteur pré-attaché à la section supérieure.

**étape 4** – Fixez le dispositif de tension

**IMPORTANT**– Le dispositif de tension doit être fixé comme détaillé dans ces instructions pour que votre store fonctionne correctement.

Si possible, demandez à une personne de maintenir le couvercle de chaîne vers le haut et à l'écart lors de l'installation du dispositif de tension.

Tout en tenant le dispositif de tension d'une main, éloignez le piston de la chaîne

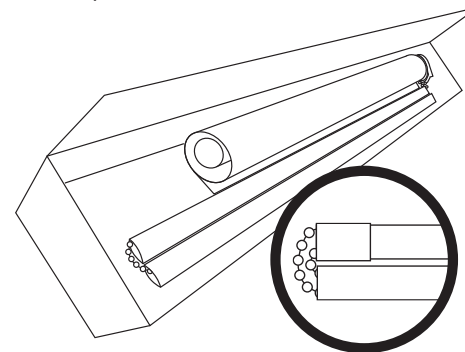

La couverture des stores plus grands sera composée de deux sections qui sont

# ROLLER SHADES

## LIFT SYSTEM: CORDLESS LIFT



The difficulty level of this installation is ranked at **Level 2**. *You got this!*

If you have questions or get stuck, call our Customer Care Team at 888-685-1735, or email [info@selectblindscanada.ca](mailto:info@selectblindscanada.ca)

### HARDWARE AND PARTS INCLUDED

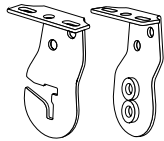

EXPOSED ROLL BRACKETS

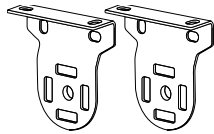

EXPOSED ROLL BRACKETS  
(LARGE SHADES ONLY)

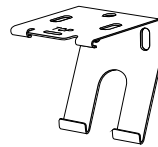

STANDARD CASSETTE  
BRACKETS\*

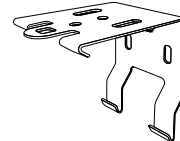

LARGE CASSETTE  
BRACKETS\*

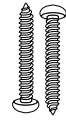

INSTALLATION  
SCREWS

\*The quantity of brackets you receive will depend on the width of your cassette headrail.

### TOOLS REQUIRED



PENCIL



TAPE MEASURE



POWER DRILL



5/64" DRILL BIT



PHILLIPS BIT



PHILLIPS SCREWDRIVER



LEVEL



STEP LADDER

## 1. MOUNTING THE BRACKETS

### MOUNTING EXPOSED ROLL BRACKETS

If your shade is smaller than 72" in width and height, you will receive an **IDLE BRACKET** and a **PIN BRACKET**. If your shade is larger than 72" in width or height, you will receive two **UNIVERSAL BRACKETS**.

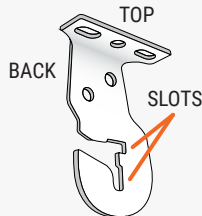

IDLE BRACKET

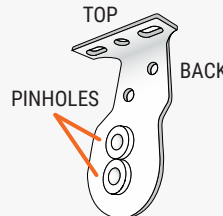

PIN BRACKET

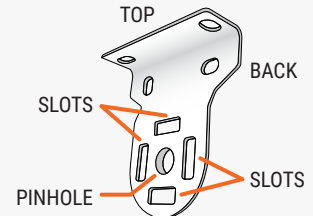

UNIVERSAL BRACKET

**NOTE:** Before you begin installing a shade with idle and pin brackets, it's important to determine which bracket belongs on the left, and which belongs on the right. Use the guide below to determine how your brackets will need to be positioned in the window. The roll position will not change how the brackets are positioned if you're installing a shade with universal brackets.

**Standard Roll:** Install your shade in the **STANDARD ROLL POSITION** if the fabric hangs from the back of the roller tube. The idle bracket will be placed on the left side of the window, and the pin bracket will be placed on the right side of the window.

**Reverse Roll:** If the fabric hangs from the front of the roller tube, install your shade in the **REVERSE ROLL POSITION**. The idle bracket will be placed on the right side of the window with the slots facing the window, and the pin bracket will be placed on the left side.

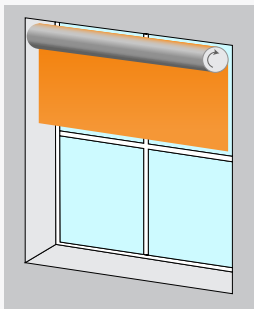

STANDARD ROLL POSITION



LEFT BRACKET

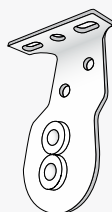

RIGHT BRACKET

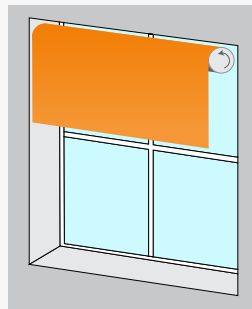

REVERSE ROLL POSITION

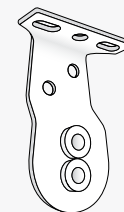

LEFT BRACKET



RIGHT BRACKET

## EXPOSED ROLL - INSIDE MOUNT

**NOTE:** The steps for mounting an exposed roll shade are the same, regardless of the bracket style you received. Before you begin, make sure you've identified your left and right brackets using the guide on page 1.

1. At the top-right corner of the window, measure how deep you wish to place your bracket (at least 2 1/4" required), and make a mark with your pencil. Repeat this step at the top-left corner of the window, using the same depth measurement.
2. Set your right-side bracket in the window so that the back edge aligns with your mark. Hold the bracket in position and use your pencil to mark through either the top screw holes (**TOP MOUNT**), or the back screw holes (**SIDE MOUNT**). Repeat this with your left-side bracket.
3. Pre-drill holes with a 5/64" drill bit at your previous marks on each side of the window.
4. Line up each bracket with the holes you drilled, and insert the screws. Once you have secured both brackets, you're ready to mount the shade (see page 5).

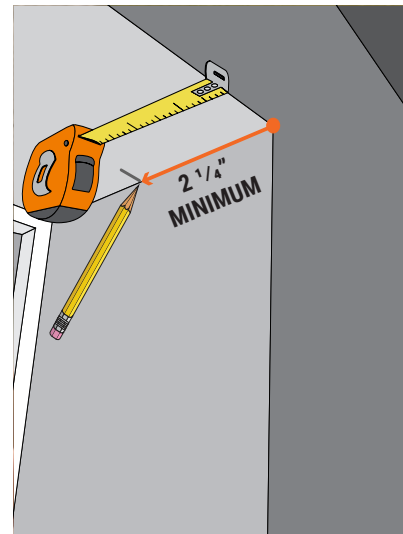

*Example shown:* Standard Roll - Idle Bracket (Left)

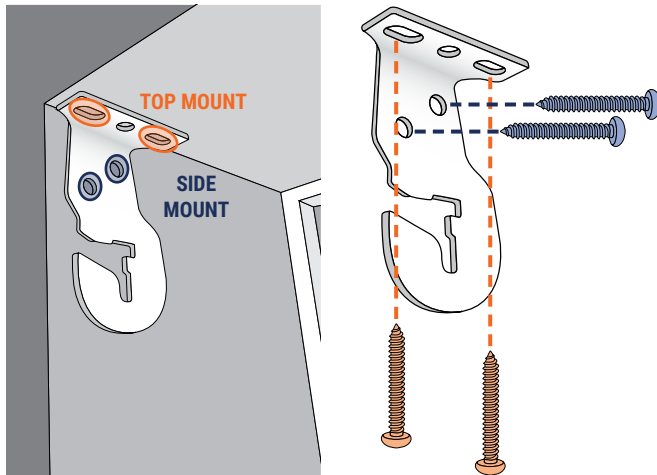

*Example shown:* Standard Roll - Pin Bracket (Right)

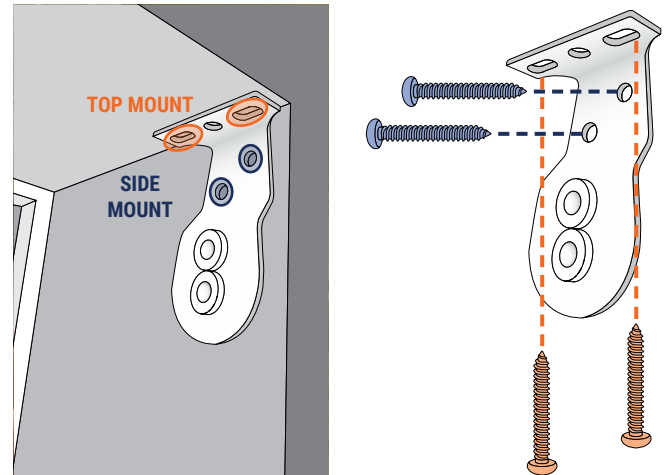

## EXPOSED ROLL - OUTSIDE MOUNT

**NOTE:** The steps for mounting an exposed roll shade are the same, regardless of the bracket style you received. Before you begin, make sure you've identified your left and right brackets using the guide on page 1.

1. At the top-left and top-right corners of the window, measure the height you wish to place your brackets (at least 2" required) and make a mark with your pencil.
2. Determine the difference in width between your shade and your window, and then divide it in half. From your previous marks, measure this distance away from the window, and make another mark with your pencil.

**EXAMPLE:** If your window is 48" wide and your roller shade is 52", the difference is 4". This means we measure and mark 2" away from the window, starting at the previous marks.

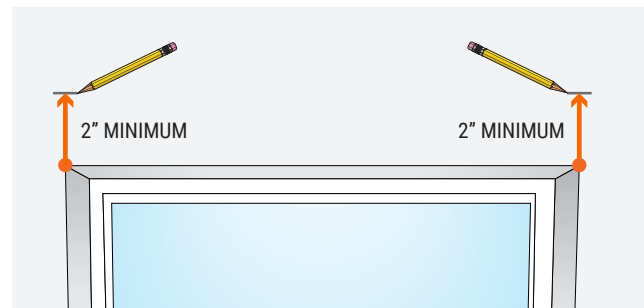

3. Center the right-side bracket at the outermost mark as shown, and use your pencil to mark the screw holes. Repeat this step with your left-side bracket at the outer-left mark.

4. Pre-drill the screw holes with a 5/64" drill bit at your marks on both sides of the window. Before you attach the brackets, you may want to erase any pencil marks that remain on the mounting surface.

5. Line up your right-side bracket with the screw holes, and insert two screws to secure the bracket to the mounting surface. Repeat this step for your left-side bracket. When both brackets are secure, the next step is to set the roller shade in the window (see page 5).

**Example shown:**  
Standard Roll - Idle Bracket (Left)

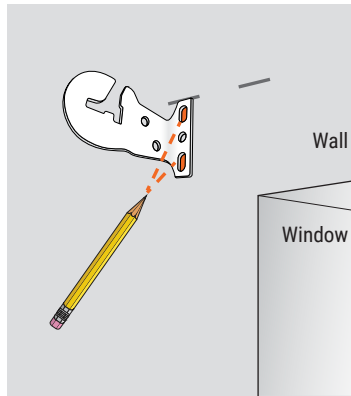

**Example shown:**  
Standard Roll - Pin Bracket (Right)

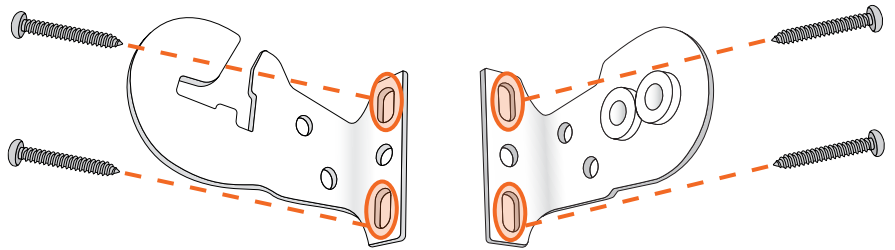
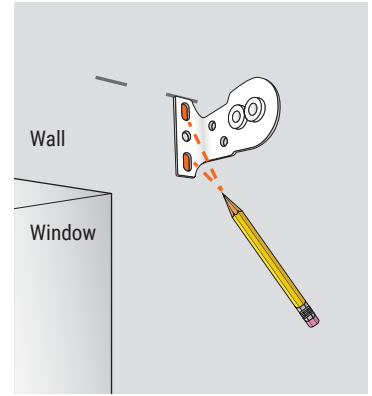

### MOUNTING CASSETTE HEADRAIL BRACKETS

**NOTE:** The roller shade tube is pre-installed in the cassette headrail, which simply snaps onto the provided hardware. You will receive two or more cassette brackets, depending on the width of your shade. **STANDARD CASSETTE BRACKETS** are included for cassette headrails 96" wide or smaller. **LARGE CASSETTE BRACKETS** are included for headrails over 96" wide.

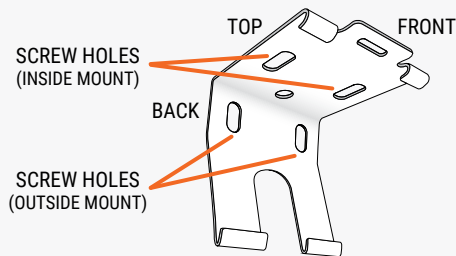

**STANDARD CASSETTE BRACKET**

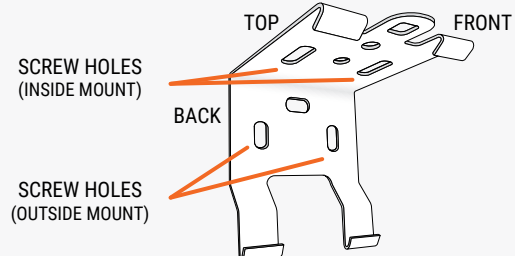

**LARGE CASSETTE BRACKET**

### CASSETTE HEADRAIL - INSIDE MOUNT

1. At the top corners of the window, measure inward and mark with your pencil 2" - 4" from each side. If you have additional brackets, make an additional mark for each one, evenly spaced between the outer marks.

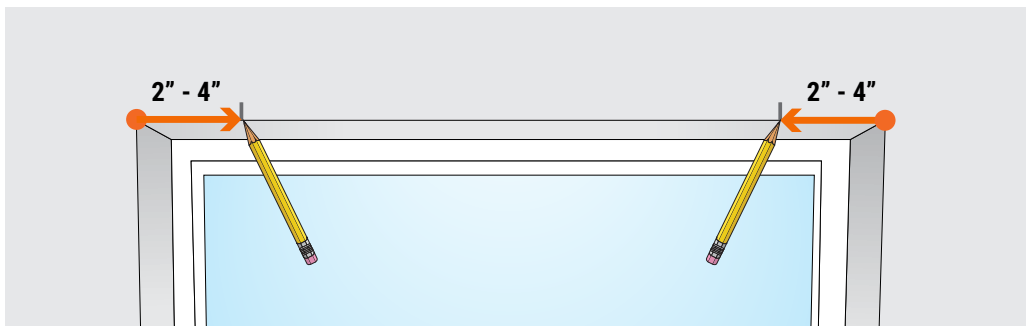



2. Next, you'll need to measure how deep to place your brackets in the window. Starting at one of your marks, measure back at least 2 5/8", and make a mark with your pencil. If you want the front of the cassette to be flush with the wall, measure back 3 1/4" and make a mark. Repeat this step until you've marked the same depth measurement for each bracket.

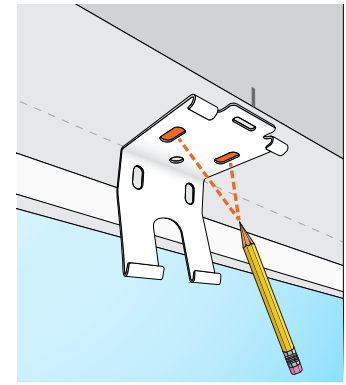
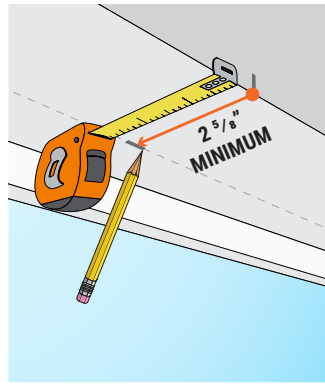

3. Position a bracket at the top of the window so that the back aligns with your mark. Make sure the front end of the bracket is parallel with the top edge of the window, then use your pencil to mark where the screws will go. Repeat this step until you've marked the screw holes for each bracket.

4. Pre-drill the screw holes with a 5/64" drill bit at your marks for each bracket location. Before you mount the brackets, you may want to erase any pencil marks that remain on the wall or window.

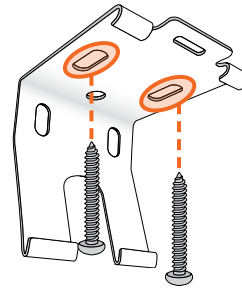

5. Line up your first bracket with the screw holes, and insert two screws to secure the bracket to the mounting surface. Repeat this step for any remaining brackets. When all brackets are secure, the next step is to set the roller shade in the window (see page 5).

### CASSETTE HEADRAIL - OUTSIDE MOUNT

1. At the top corners of the window, measure inward and mark with your pencil 2" - 4" from each side. If you have additional brackets, make an additional mark for each one, evenly spaced between the outer marks.

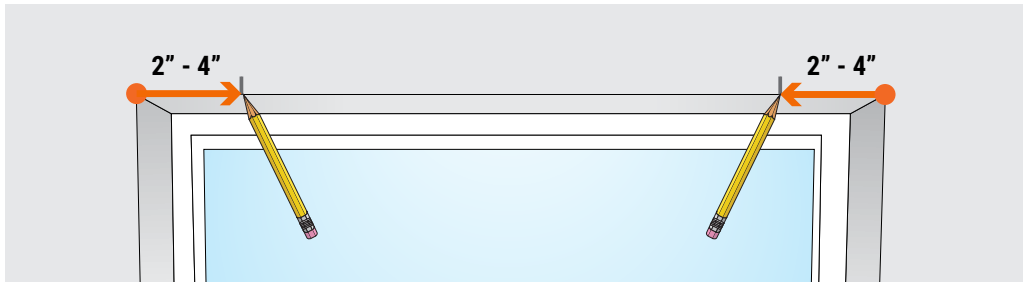

2. From one of these marks, measure upward and mark the height for the bracket placement. The minimum requirement is 1", but if you want the brackets to clear the top of the window, measure and mark at least 2 1/4" above your window. Repeat this until you've marked the same height measurement for each bracket.

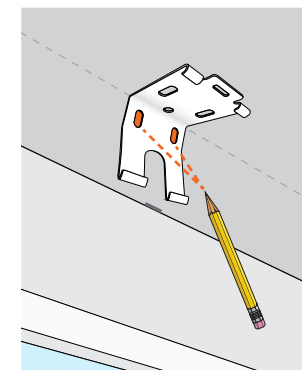
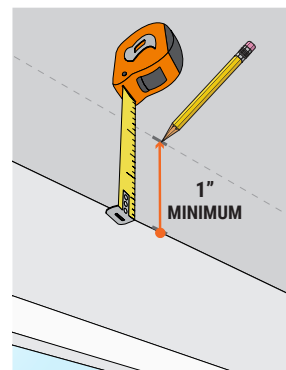

3. Position a bracket so that the back is against your mounting surface, and the top is aligned with one of your upper marks. Hold the bracket in place and mark with your pencil where the screws will go. Repeat this until you've marked the screw holes for each bracket.

4. Pre-drill the screw holes with a 5/64" drill bit at your marks for each bracket location. Before you mount the brackets, you may want to erase any pencil marks that remain on the mounting surface.

5. Line up your first bracket with the screw holes, and insert two screws to secure the bracket to the mounting surface. Repeat this step for any remaining brackets. When all brackets are secure, the next step is to set the roller shade in the window (see page 5).

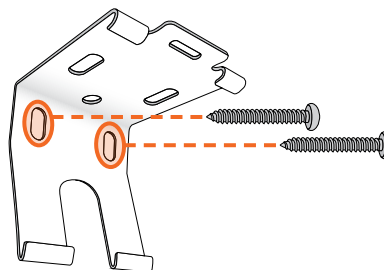

## 2. ATTACHING THE SHADE

**NOTE:** Before you attach the shade to the brackets, check that your brackets are straight and aligned with each other. The screw holes on all brackets are elongated, so making small adjustments is easy.

**Inside Mount:** Use a tape measure to check that each bracket is set to the same depth. If you need to make adjustments, slightly loosen the screws on a bracket and shift it back or forward. Secure the screws when the position is corrected.

**Outside Mount:** Use a tape measure to check that each bracket is set to the same height, and use a level on top of each bracket to make sure they're all straight and aligned. If you need to make adjustments, slightly loosen the screws on a bracket and shift it until it's level and set to the correct height.

### STANDARD EXPOSED ROLL

**NOTE:** The pin bracket has two pinholes, and the idle bracket has two slots. Make sure to match the pinhole and slot correctly when attaching the shade. The **ORANGE (#1)** arrow indicates how to attach the shade for inside mount, and the **BLUE (#2)** arrow indicates how to attach the shade for outside mount.

1. While holding the roller shade in your hands, locate the compressible pin on the right end of the shade. Set this pin into one of the plastic rings on the pin bracket.
2. With the pin inserted and compressed, locate the tab on the left end of the shade. Set this tab onto the corresponding slot in the idle bracket as shown.

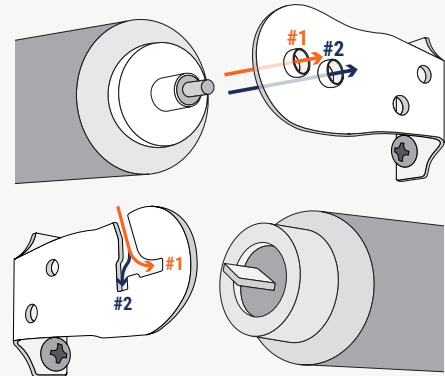

### REVERSE EXPOSED ROLL

**NOTE:** Refer to the "Reverse Roll" section on page 1 to see the correct bracket orientation for inside mount. For outside mount, the idle bracket must face away from the window, so that the "hook" still faces upward. The **ORANGE (#1)** arrow indicates how to attach the shade for inside mount, and the **BLUE (#2)** arrow indicates how to attach the shade for outside mount.

1. While holding the roller shade in your hands, locate the compressible pin on the left end of the shade. Set this pin into one of the plastic rings on the pin bracket.
2. With the pin inserted and compressed, locate the tab on the right end of the shade. Set this tab onto a slot in the idle bracket as shown. The inner slot is for outside mount, and the outer slot is for inside mount.

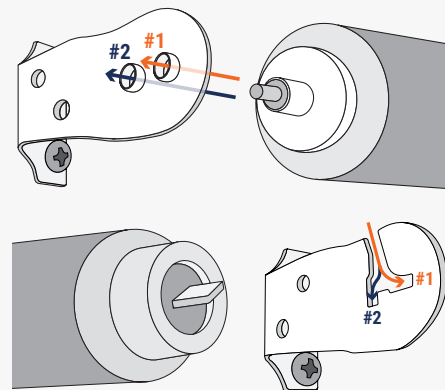

### UNIVERSAL EXPOSED ROLL

**NOTE:** Standard roll shades have a pin on the right end, and reverse roll shades have the pin on the left. The pin end of the shade should be attached first, followed by the opposite end with prongs.

1. While holding the roller shade in your hands, locate which end of the shade has the compressible pin. Slide this pin into the center pinhole on your first bracket.
2. With the pin inserted and compressed, locate the two rectangular prongs on the opposite end of the shade. Set these prongs onto the second bracket through the corresponding slots, as shown.

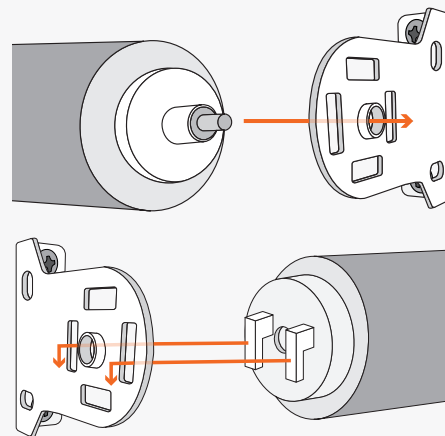

## STANDARD AND LARGE CASSETTE HEADRAIL

1. Grab the cassette and hold it up to your brackets. Set the back edge of the headrail onto the bottom tab of each bracket. While in this position, you can slide the shade left or right until the cassette is centered.

2. When you're ready to secure the headrail, push the headrail back until the top of each bracket snaps onto the top of the cassette.

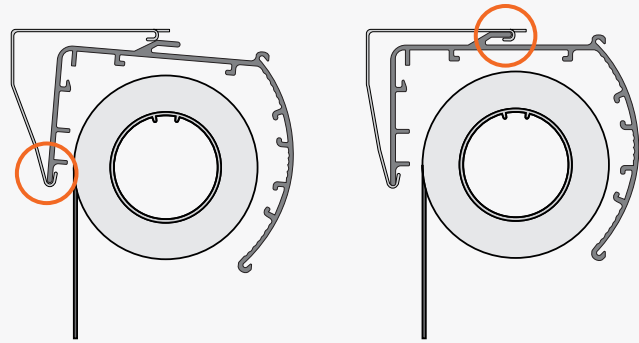

## 3. ADDITIONAL INSTRUCTIONS

### HOW TO OPERATE

**NOTE:** Do not pull on the side of the shade fabric; this can cause the fabric to misalign or become dirty. A cordless roller shade should only be operated by pulling the bottom hem bar. We recommend using two hands when lifting or lowering the shade.

1. To lower the shade, grip the hem bar and gently pull straight down to the desired position.
2. To raise the shade, grip the hem bar and gently tug down to release the lock mechanism. Slowly guide the shade up without releasing your grip, and gently tug down to lock the shade in position.

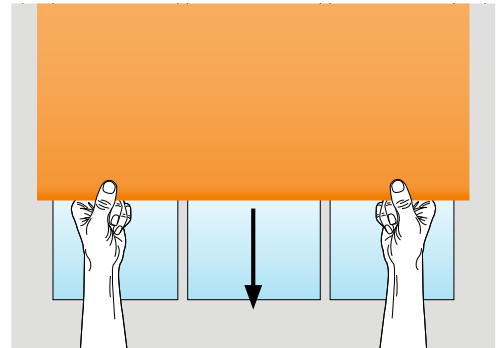

### ADJUSTING TENSION

**NOTE:** You can change the speed of your shade by adjusting the spring tension. If the shade is too slow, increase the tension; if the shade is too fast, decrease tension.

1. Lower the shade about 18" from the top if you need to increase tension, or raise the shade to the top if you need to decrease tension.

2. Remove the shade from the window, but leave your brackets installed.

**A. Exposed Roll:** Grip the roller with both hands and disengage the idle end of the shade. Then shift the roller away from the pin bracket.

**B. Cassette Headrail:** Grip the cassette with both hands. While firmly pushing it toward the window, roll the front downward and then lift the cassette away. Remove the covers from each end of the cassette, and then disengage the roller tube from the internal hardware. You may need a flathead screwdriver to compress the pin.

3. To increase tension, carefully roll up the shade with your hands and then reattach it to the brackets. To decrease tension, carefully unroll the shade with your hands and then reattach it to the brackets. Repeat these steps until you've reached the desired tension.



IDLE BRACKET

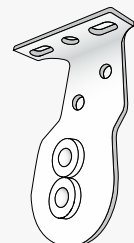

PIN BRACKET

### ATTACHING THE BRACKET COVERS

#### UNIVERSAL BRACKETS - OUTSIDE MOUNT

**NOTE:** Bracket covers are only provided for outside mounted exposed roll shades installed onto universal brackets. These are used for hiding the brackets and the components on each end of the roller shade.

1. Slide a cover onto each bracket until it snaps in position. Use the illustration as your guide.

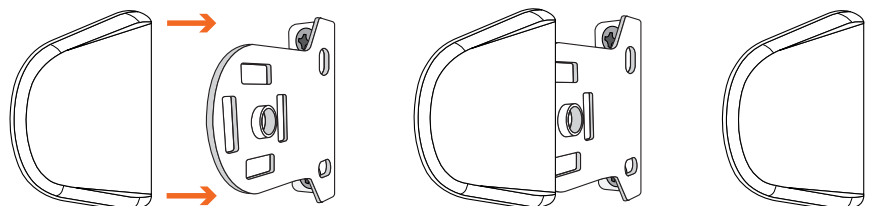



## CLEANING INSTRUCTIONS

**NOTE:** All fabrics are different and some may be easier to clean than others. We recommend cleaning your shades as often as once a month. Here are some general guidelines on how to do so:

1. For regular maintenance, use a duster or a vacuum with a brush attachment and run it over the front and back of the shade.
2. To spot clean stains, use a damp rag with a very mild, gentle detergent or soap. Dab at the affected spots; do NOT rub! Let the dampened area air-dry and repeat as necessary.

## WARRANTY AND REPLACEMENT

To learn more about our product warranties, please visit: <https://www.selectblindscanada.ca/warranty>

For replacement parts, and/or to file a warranty claim for a product that is damaged, defective, or missing parts, please call our Customer Care Team at 888-685-1735, or email [info@selectblindscanada.ca](mailto:info@selectblindscanada.ca).

## WARNING

**STRANGULATION HAZARD** — Young children can be strangled by cords. Immediately remove this product if a cord longer than 22 cm or a loop exceeding 44 cm around becomes accessible.

# ROLLER SHADES

## LIFT SYSTEM: MOTORIZATION



The difficulty level of this installation is ranked at **Level 2**. *You got this!*

If you have questions or get stuck, call our Customer Care Team at 888-685-1735, or email [info@selectblindscanada.ca](mailto:info@selectblindscanada.ca)

### HARDWARE AND PARTS INCLUDED

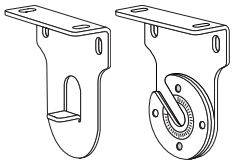

EXPOSED ROLL BRACKETS

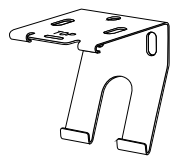

STANDARD CASSETTE BRACKETS\*

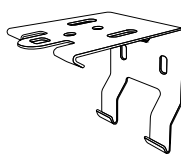

LARGE CASSETTE BRACKETS\*

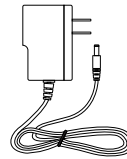

BATTERY CHARGER

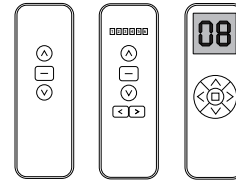

REMOTE CONTROL (1, 6, AND 16-CHANNEL)

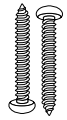

INSTALLATION SCREWS

\*The quantity of brackets you receive will depend on the width of your cassette headrail.

### TOOLS REQUIRED



PENCIL



TAPE MEASURE



POWER DRILL



5/64" DRILL BIT



PHILLIPS BIT



PHILLIPS SCREWDRIVER



LEVEL



STEP LADDER

## 1. MOUNTING THE BRACKETS

### MOUNTING EXPOSED ROLL BRACKETS

The motor is hidden inside the roller tube on the right end of the shade. The **MOTOR BRACKET** goes on the right side of your window, and the **PIN BRACKET** goes on the left side. Regardless of your roll position (standard or reverse roll), the brackets are positioned the same.

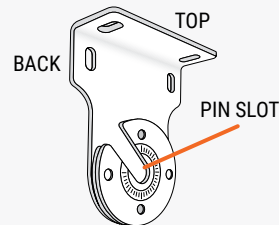

**PIN BRACKET (LEFT)**

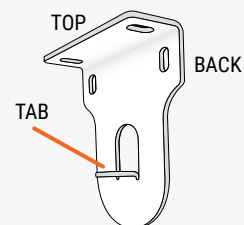

**MOTOR BRACKET (RIGHT)**

### EXPOSED ROLL - INSIDE MOUNT

**NOTE:** The steps for mounting an exposed roll shade are the same, regardless of the bracket style you received.

1. At the top-right corner of the window, measure how deep you wish to place your bracket (at least 2 1/4" required), and make a mark with your pencil. Repeat this step at the top-left corner of the window, using the same depth measurement.
2. Set the motor bracket in the window so that the back edge aligns with your mark. Hold the bracket in position and use your pencil to mark through the top screw holes. Repeat this step with your pin bracket on the left side of the window.
3. Pre-drill holes with a 5/64" drill bit at your previous marks on each side of the window.

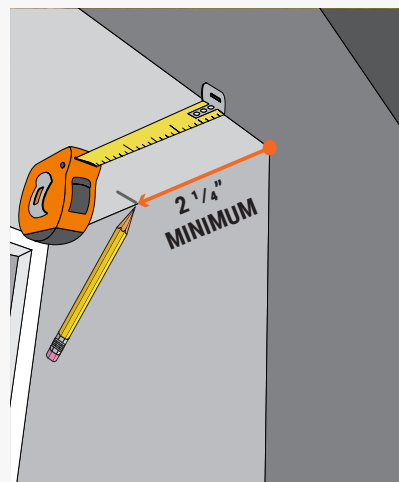

4. Line up each bracket with the holes you drilled, and insert the screws. Once you have secured both brackets, you're ready to mount the shade into the window (see page 16).

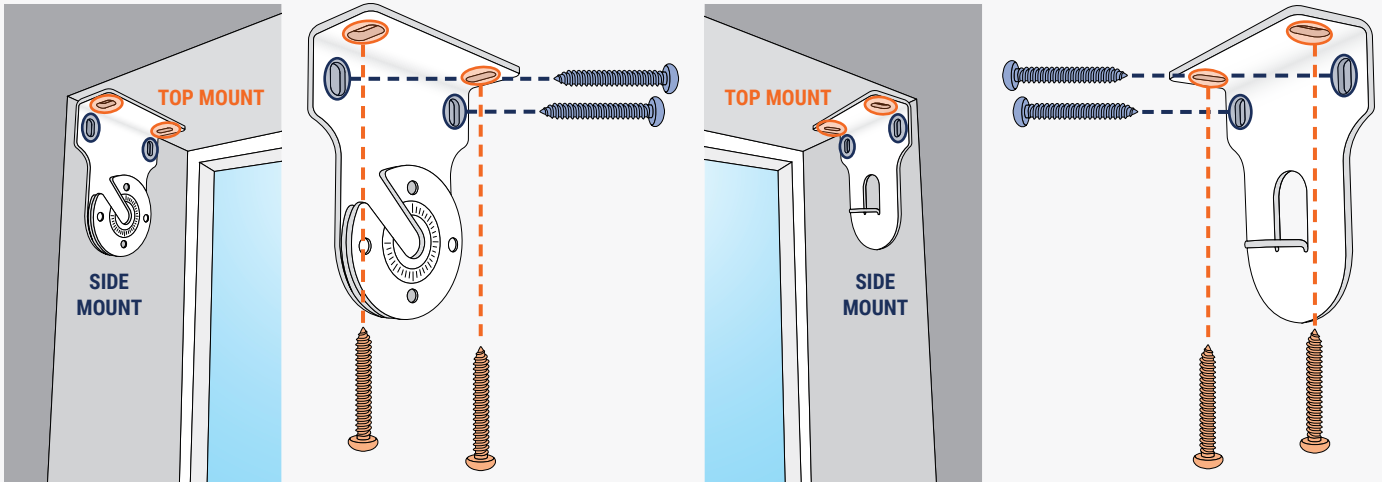

### EXPOSED ROLL - OUTSIDE MOUNT

**NOTE:** The steps for mounting an exposed roll shade are the same, regardless of the bracket style you received.

1. At the top-left and top-right corners of the window, measure the height you wish to place your brackets (at least 2" required) and make a mark with your pencil.
2. Determine the difference in width between your shade and your window, and then divide it in half. From your previous marks, measure this distance away from the window, and make another mark with your pencil.

**EXAMPLE:** If your window is 48" wide and your roller shade is 52", the difference is 4". This means we measure and mark 2" away from the window, starting at the previous marks.

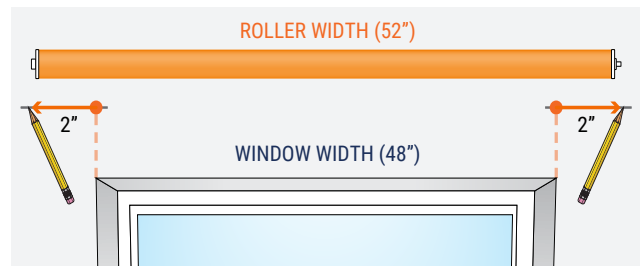
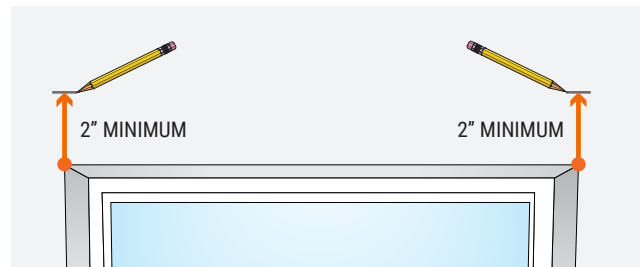

3. Center the motor bracket at the outermost mark as shown, and use your pencil to mark the screw holes. Repeat this step with your pin bracket at the outer-left mark.
4. Pre-drill the screw holes with a 5/64" drill bit at your marks on both sides of the window. Before you attach the brackets, you may want to erase any pencil marks that remain on the mounting surface.
5. Line up your motor bracket with the screw holes, and insert two screws to secure the bracket to the mounting surface. Repeat this step for your pin bracket. When both brackets are secure, you're ready to mount the shade into the window (see page 16).

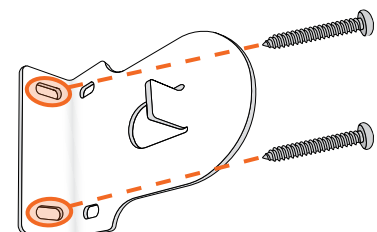
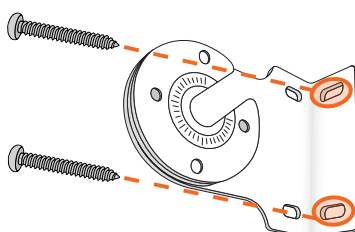
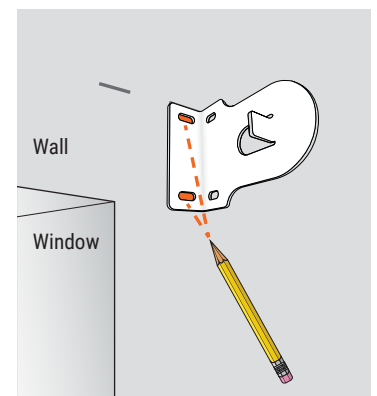
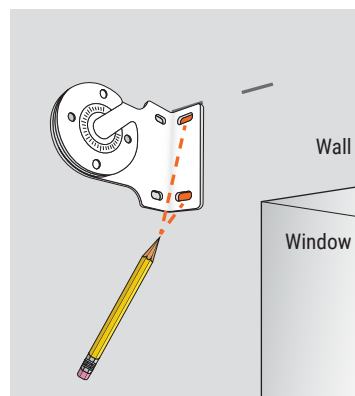

## MOUNTING CASSETTE HEADRAIL BRACKETS

**NOTE:** The roller shade tube is pre-installed in the cassette headrail, which simply snaps onto the provided hardware. You will receive two or more cassette brackets, depending on the width of your shade. **STANDARD CASSETTE BRACKETS** are included for cassette headrails 96" wide or smaller. **LARGE CASSETTE BRACKETS** are included for headrails over 96" wide.

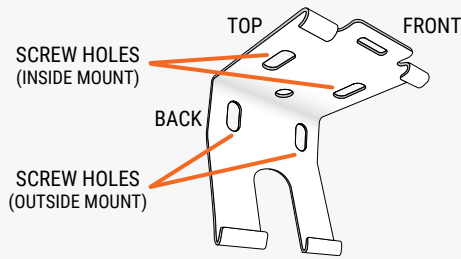

**STANDARD CASSETTE BRACKET**

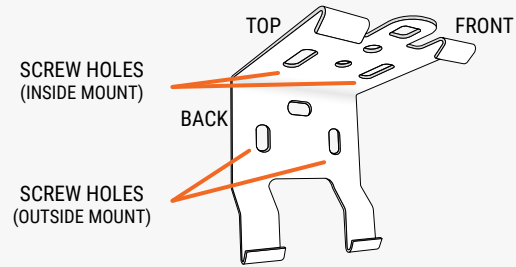

**LARGE CASSETTE BRACKET**

## CASSETTE HEADRAIL - INSIDE MOUNT

**1.** At the top corners of the window, measure inward and mark with your pencil 2" - 4" from each side. If you have additional brackets, make an additional mark for each one, evenly spaced between the outer marks.

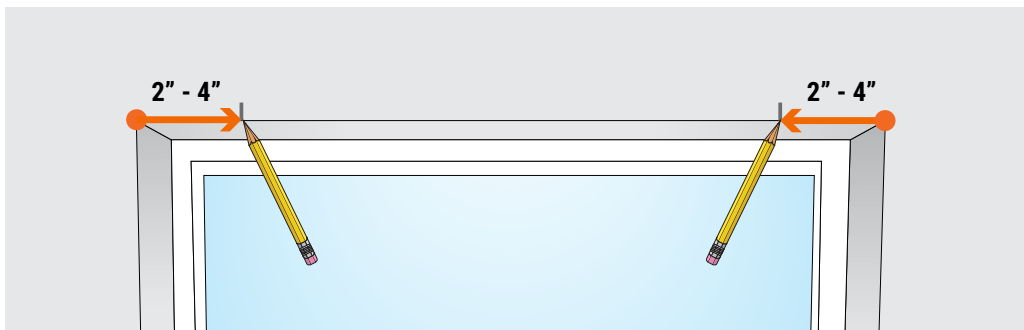

**2.** Next, you'll need to measure how deep to place your brackets in the window. Starting at one of your marks, measure back at least 2 5/8", and make a mark with your pencil. If you want the front of the cassette to be flush with the wall, measure back 3 1/4" and make a mark. Repeat this step until you've marked the same depth measurement for each bracket.

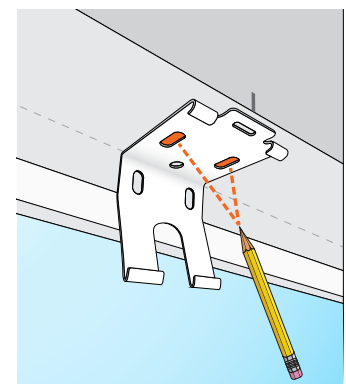
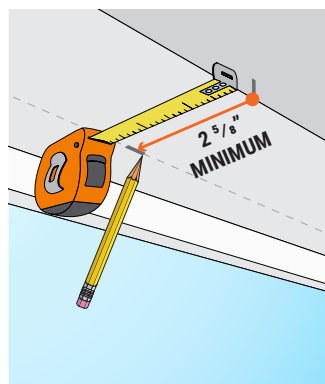

**3.** Position a bracket at the top of the window so that the back aligns with your mark. Make sure the front end of the bracket is parallel with the top edge of the window, then use your pencil to mark where the screws will go. Repeat this step until you've marked the screw holes for each bracket.

**4.** Pre-drill the screw holes with a 5/64" drill bit at your marks for each bracket location. Before you mount the brackets, you may want to erase any pencil marks that remain on the wall or window.

**5.** Line up your first bracket with the screw holes, and insert two screws to secure the bracket to the mounting surface. Repeat this step for any remaining brackets. When all brackets are secure, you're ready to mount the shade into the window (see page 16).

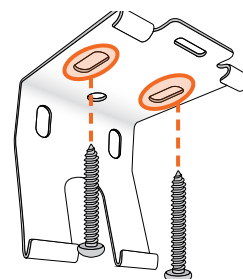

## CASSETTE HEADRAIL - OUTSIDE MOUNT

1. At the top corners of the window, measure inward and mark with your pencil 2" - 4" from each side. If you have additional brackets, make an additional mark for each one, evenly spaced between the outer marks.



2. From one of these marks, measure upward and mark the height for the bracket placement. The minimum requirement is 1", but if you want the brackets to clear the top of the window, measure and mark at least 2 1/4" above your window. Repeat this until you've marked the same height measurement for each bracket.

3. Position a bracket so that the back is against your mounting surface, and the top is aligned with one of your upper marks. Hold the bracket in place and mark with your pencil where the screws will go. Repeat this until you've marked the screw holes for each bracket.

4. Pre-drill the screw holes with a 5/64" drill bit at your marks for each bracket location. Before you mount the brackets, you may want to erase any pencil marks that remain on the mounting surface.

5. Line up your first bracket with the screw holes, and insert two screws to secure the bracket to the mounting surface. Repeat this step for any remaining brackets. When all brackets are secure, you're ready to mount the shade into the window (see below).

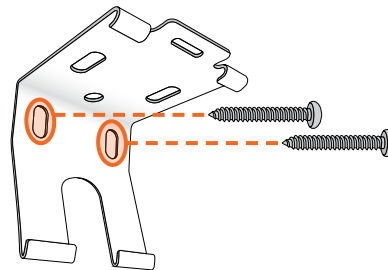
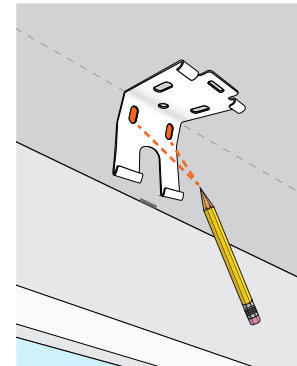
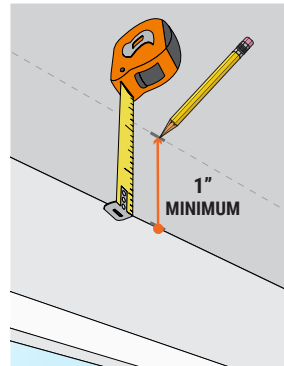

## 2. ATTACHING THE SHADE

**NOTE:** Before you attach the shade to the brackets, check that your brackets are straight and aligned with each other. The screw holes on all brackets are elongated, so making small adjustments is easy.

**Inside Mount:** Use a tape measure to check that each bracket is set to the same depth. If you need to make adjustments, slightly loosen the screws on a bracket and shift it back or forward. Secure the screws when the position is corrected.

**Outside Mount:** Use a tape measure to check that each bracket is set to the same height, and use a level on top of each bracket to make sure they're all straight and aligned. If you need to make adjustments, slightly loosen the screws on a bracket and shift it until it's level and set to the correct height.

### EXPOSED ROLL

1. While holding the roller shade in your hands, locate the gear-shaped hole in the motor head on the right end of the shade. Slide this hole firmly onto the tab of the motor bracket.

2. Locate the pin on the left end of the shade, and gently slide it into the center slot on the pin bracket.

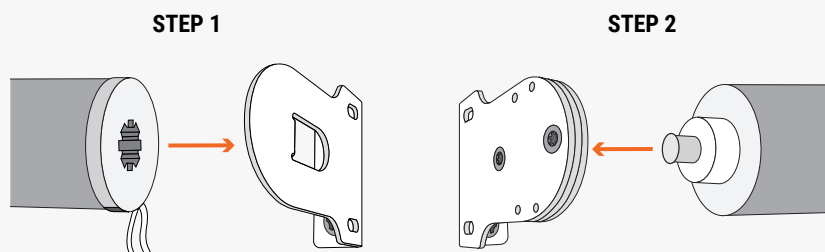

## STANDARD AND LARGE CASSETTE HEADRAIL

1. Grab the cassette and hold it up to your brackets. Set the back edge of the headrail onto the bottom tab of each bracket. While in this position, you can slide the shade left or right until the cassette is centered.

2. When you're ready to secure the headrail, push the headrail back until the top of each bracket snaps onto the top of the cassette.

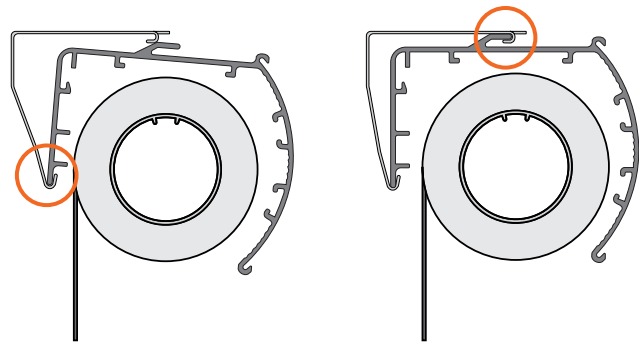

## 3. PROGRAMMING AND USING YOUR REMOTE

**IMPORTANT:** While it is not necessary to follow the steps below, we recommend familiarizing yourself with the basics of programming the motor and your remote to better understand how your motorized shade works. Please note that the batteries in your shade's motor were fully charged at the factory prior to shipment. Your shade's upper and lower limits (when it's fully raised or lowered) have also been pre-set. A channel number has also been assigned to each shade on your remote.

DO NOT attempt to raise or lower your motorized shade with your hands. This may cause permanent damage to the motor, and other components in the headrail, which may not be covered under your warranty.

### OPERATIONAL FUNCTIONS

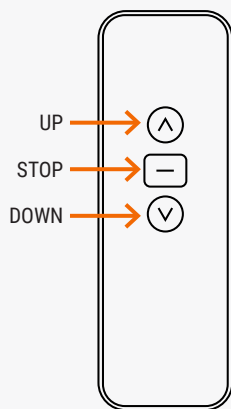

1-CHANNEL REMOTE

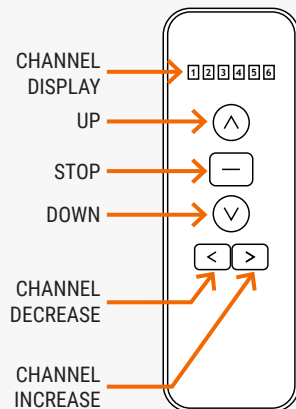

6-CHANNEL REMOTE

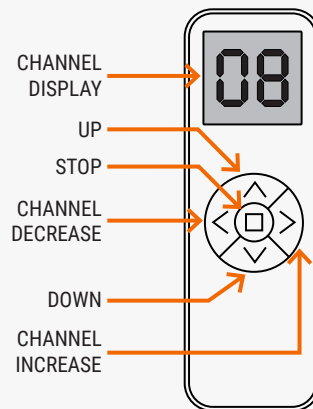

16-CHANNEL REMOTE

### PROGRAMMING FUNCTIONS

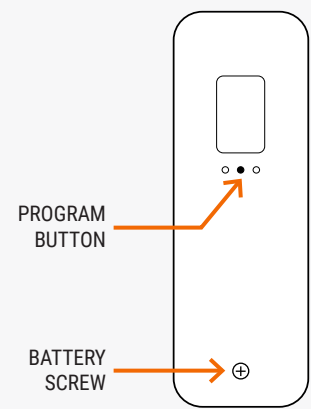

BACKSIDE OF REMOTE

## PAIRING A SINGLE SHADE TO A CHANNEL

1. Press the **CHANNEL INCREASE** or **CHANNEL DECREASE** button on the remote to select a dedicated channel for the first shade you're pairing with the remote.

2. Locate the **MOTOR HEAD** on the left end of the roller tube under the headrail. Press and hold the **PROGRAM** button until you hear a beep and the shade "jogs" quickly up and down.

3. Press the **UP** button on the remote and the shade will jog again.

4. Congrats! Your shade and remote are now paired. Repeat this process for any additional shades you want to pair with the remote, selecting a new channel (if using a multi-channel remote) before you begin.

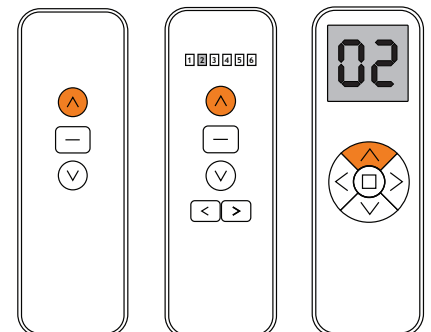
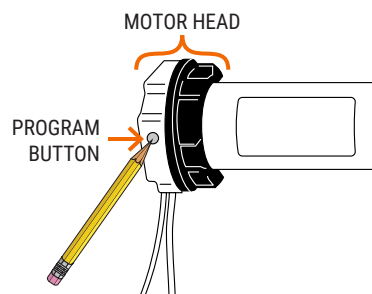



## ADJUSTING THE UPPER/LOWER LIMITS

Your shade's upper and lower limits are already pre-set at the factory, so the following steps are only necessary if you want to change how these settings are configured. The upper limit can ONLY be changed after performing a factory reset (see page 19).

### CHANGING THE UPPER LIMIT

1. Move the shade using the **UP** or **DOWN** buttons, until it is positioned about 6" below the desired upper limit.
2. Press the **PROGRAM** button on the back of the remote. The shade will jog, indicating it's now in programming mode.
3. Press the **UP** button to move the shade to the desired upper limit. Press the **PROGRAM** button on the back of the remote again and the shade will jog.
4. That's it! You've now reset your shade's upper limit, and the motor will exit programming mode automatically.

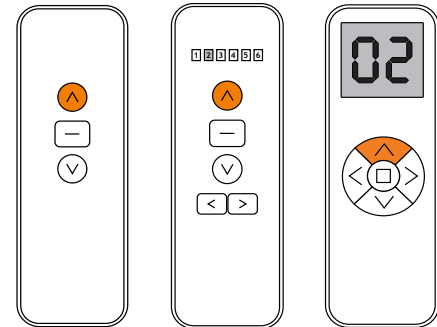
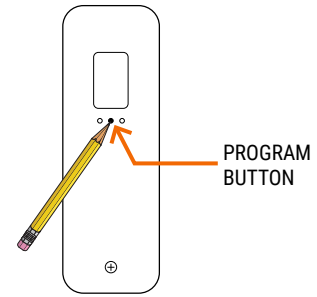

### CHANGING THE LOWER LIMIT

1. Move the shade using the **UP** or **DOWN** buttons, until it is positioned about 6" above the desired lower limit.
2. Press the **PROGRAM** button on the back of the remote. The shade will jog, indicating it's now in programming mode.
3. Press the **DOWN** button to move the shade to the desired lower limit. Press **PROGRAM** on the back of the remote again and the shade will jog.
4. That's it! The lower limit is set, and the motor will exit programming mode automatically.

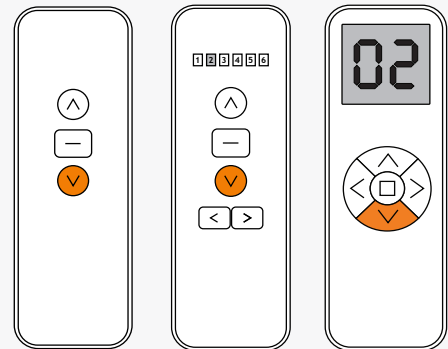

### SETTING INTERMEDIATE POSITIONS

**NOTE:** You can set up to four (4) intermediate positions between the shade's upper and lower limits. Each intermediate position must be at least 6" away from the upper and lower limits, and any other intermediate limits you program.

1. Move the shade using the **UP** or **DOWN** buttons until it's at least 6" away from any other limits.
2. Press the **PROGRAM** button on the back of the remote. The shade will jog, indicating it's now in programming mode.
3. Use the **UP** or **DOWN** button to move the shade to the desired stopping position and press the **PROGRAM** button again. The shade will jog, indicating the new stopping point is now set.
4. Repeat these steps to add up to four intermediate stopping points to your shade.

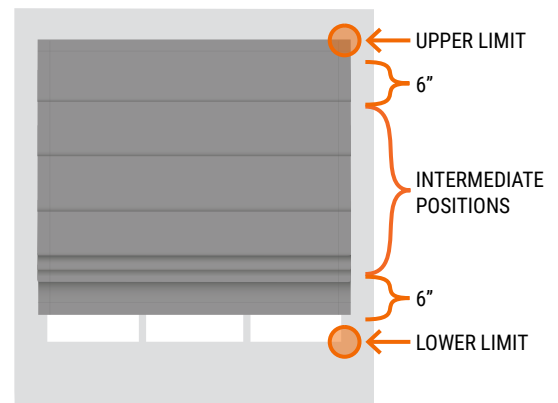

## DELETING LOWER LIMITS AND INTERMEDIATE POSITIONS

**NOTE:** Lower limits and intermediate positions can be deleted and reassigned. Upper limits can only be removed by performing a factory reset.

1. To delete a specific shade position, use the **UP** or **DOWN** buttons to move the shade to the position you want to remove.
2. Press and hold the **PROGRAM** button on the back of the remote for about 7 seconds. The shade will jog once before the 7 seconds and once after. You have now deleted the limit/position from your shade.

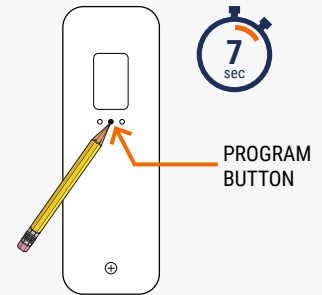

## PERFORMING A FACTORY RESET

1. Press the **PROGRAM** button on the **MOTOR HEAD** four (4) times in a row.
2. Press it again for a fifth time, holding the button down until the shade jogs twice.
3. Your shade's memory and all presets have now been erased. To use the shade again, pair it to a channel (see page 5, "Pairing a Single Shade to a Channel"), and then set new upper/lower limits.

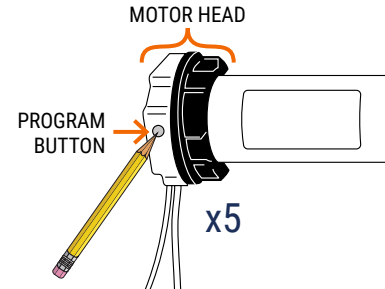

## USING THE REMOTE TO CONTROL YOUR SHADE

1. Press the **UP** or **DOWN** button once to move the shade to the next pre-set position.
2. Press the **UP** or **DOWN** button two times (once per second) and the shade will move to the upper or lower limit position without stopping at any intermediate positions.
3. When the shade is in the top position, the **UP** button becomes non-functional. Likewise, when the shade is in the bottom position, the **DOWN** button becomes non-functional.

## CONTROLLING MULTIPLE SHADES SIMULTANEOUSLY

**6 Channel Remote:** Press the **CHANNEL INCREASE** button on the remote until all 6 lights on the **CHANNEL DISPLAY** are illuminated. This activates all six channels simultaneously, which allows you to control up to 6 shades at the same time.

**16 Channel Remote:** Press the **CHANNEL INCREASE** button on the remote until you see "CC" on the **CHANNEL DISPLAY**. This activates all sixteen channels simultaneously, which allows you to control up to 16 shades at the same time.

## RECHARGING THE SHADE BATTERY

**NOTE:** If the shade begins to move at a slower pace, the battery charge may be getting low. Plug the shade into a power outlet and charge the battery for 6 hours.

1. Locate the charger cable behind the fabric on the left side of the headrail. Connect this cable to the provided battery charger.
2. Plug the battery charger into the nearest wall outlet. If the cable isn't long enough to reach an outlet, use an extension cord (not included) to bridge the gap.

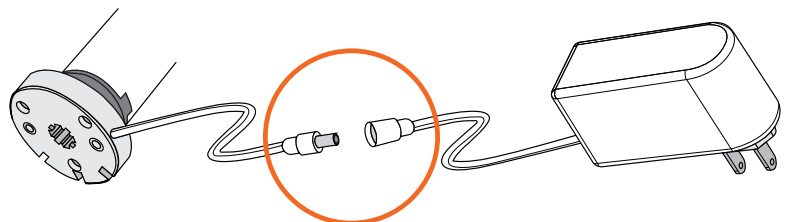

## REPLACING THE REMOTE BATTERY

**NOTE:** The battery used to power your remote is a coin-shaped 3V cell battery (CR2032). Additional batteries are not included.

1. To remove the back cover of the remote, use a small screwdriver to remove the battery screw. Gently slide the back cover up to disengage it, then lift it away from the remote.
2. Remove the old battery from the circuit board by sliding it diagonally out of the bracket holding it down. Place a new 3V cell battery in the bracket with the "+" positive side showing.
3. Replace the back cover of the remote, and secure the battery screw.

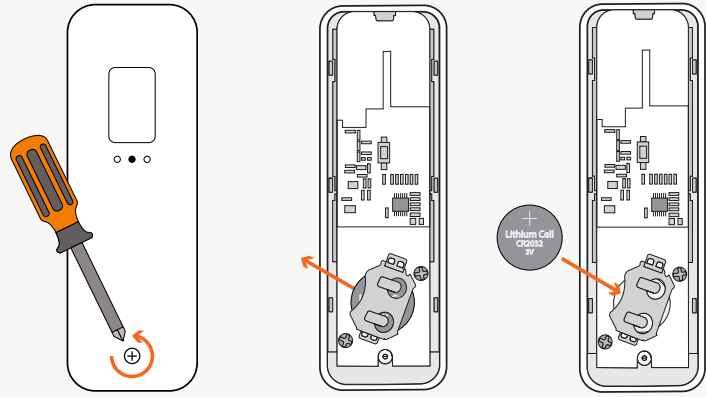

## INSTALLING A WALL MOUNT CARRIER

**NOTE:** A wall mount carrier is included with your remote, but it is optional to install it. If you choose to mount the carrier with the adhesive patch on the back, be sure to clean and dry the mounting surface first.

1. Determine where you'd like to place your remote carrier in the room. It is common to place it near a light switch, or on the wall next to the window.
2. With the carrier in the upright position, insert the provided screws to secure it to our mounting surface. If you're using the adhesive patch, remove the backing and firmly press the carrier to the clean surface for about 30 - 45 seconds.

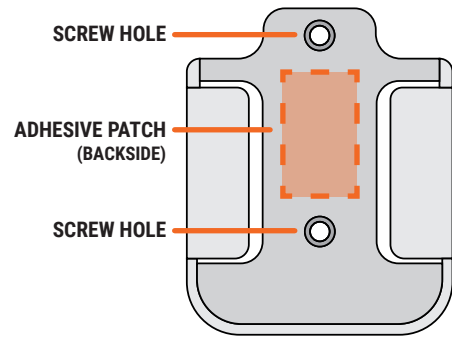

## CLEANING INSTRUCTIONS

**NOTE:** All fabrics are different and some may be easier to clean than others. We recommend cleaning your shades as often as once a month. Here are some general guidelines on how to do so:

1. For regular maintenance, use a duster or a vacuum with a brush attachment and run it over the front and back of the shade.
2. To spot clean stains, use a damp rag with a very mild, gentle detergent or soap. Dab at the affected spots; do NOT rub! Let the dampened area air-dry and repeat as necessary.

## WARRANTY AND REPLACEMENT

To learn more about our product warranties, please visit: <https://www.selectblindscanada.ca/warranty>

For replacement parts, and/or to file a warranty claim for a product that is damaged, defective, or missing parts, please call our Customer Care Team at 888-685-1735, or email [info@selectblindscanada.ca](mailto:info@selectblindscanada.ca).

## WARNING

**STRANGULATION HAZARD** — Young children can be strangled by cords. Immediately remove this product if a cord longer than 22 cm or a loop exceeding 44 cm around becomes accessible.

## Smart WiFi Hub Instructions

### 1. Download & Install "P2 POWERMATE" APP on your cellphone

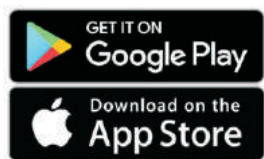

powermate smart hub



powermate

powermate APP

- (1) Search for "P2 POWERMATE" on the App Store or Google play
- (2) Download "P2 POWERMATE" and install the APP on your phone

### 2. Register and login to the P2 POWERMATE APP

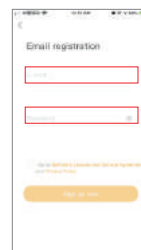

- (1) When installation is complete open P2 POWERMATE
- (2) Create an account using your e-mail address – enter a password that should include letters and numbers only, no signs or special characters
- (3) Login in to your account (after the account is established you will login to the APP directly)

### 3. Link the P2 POWERMATE hub to the POWERMATE APP

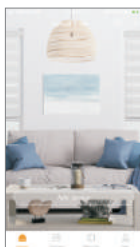

- (1) Choose "Add device" on desktop

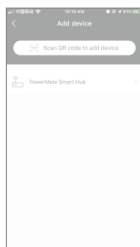

- (2) Choose P2 POWERMATE Smart Hub



- (3) Choose "AllOne Pro"



- (4) Power on the P2 POWERMATE hub



- (5) Press and hold the central button on the hub until the circular light turns RED and Flashes



- (6) Choose "Next" on the P2 POWERMATE APP



- (7) Choose "Join" to enable the hub to access your Wi-Fi network  
Tip: Make sure your network is available, not restricted to assure access



- (8) Select your Wi-Fi network and input your Wi-Fi password



- (9) The P2 POWERMATE hub will connect to your Wi-Fi network automatically. When you see "Added successfully" on the P2 POWERMATE APP, choose "Done"

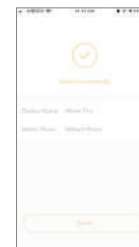

- (10) The APP is linked to the P2 POWERMATE hub when Allone Pro appears on the desktop

### 4. Add your shades to the P2 POWERMATE APP

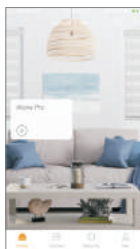

- (1) Choose "Allone Pro" on the APP desktop

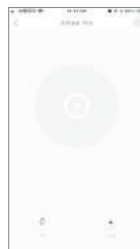

- (2) Choose "+ Add" at the menu bottom right corner

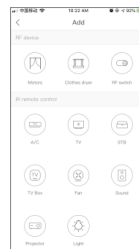

- (3) Choose "Motor" device



- (4) Now press the "programming button" on motor head for 1 second - the shade will oscillate one time. Then tap "pairing" on P2 POWERMATE APP. If the shade is successfully added to the APP, the shade will oscillate one more time.  
*If not, repeat the step 4 operation.*



- (5) Choose "Response has been stored" when the shade is successfully added to APP.



- (6) The shade has been added to the P2 POWERMATE APP. Confirm that you can now control the shade using the APP, and then proceed to add additional shades if applicable.

## 5. Family “Member Permission” management

Note that the set-up account is the one and only administrator – only the administrator's login can make changes to the APP. However, the administration account can add family members with their own ID, and they can then control the shades from their phones or tablets.

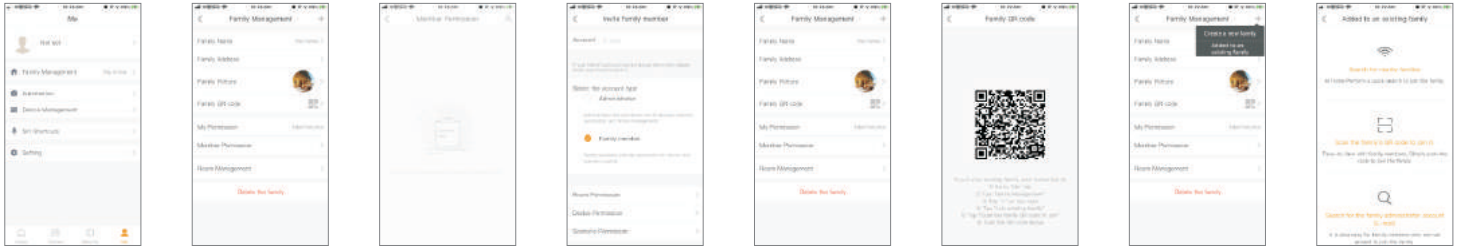

(1) Choose “Me” on the P2 POWERMATE desktop, and then Select “family Management” menu

(2) Choose “Member Permission”

(3) Tap “+” family members at the top right corner of the screen

(4) Input your family “Account e-mail address” then go to invitation to your family member

(5) When your family member receives and accepts the invitation, the Administration account shows the family QR Code that the family member will scan. The family member taps “+” at the top right corner, and chooses “Add to an existing family”. Choose “scan the family’s QR code to join it”, and then scan the code on the administrators screen.

## 6. “Siri Shortcut” Voice Command Management

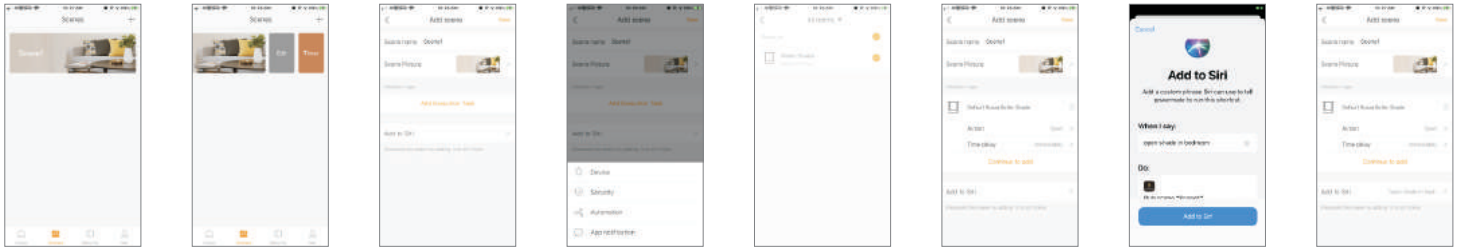

(1) Choose “Scenes” on the P2 POWERMATE desktop. Create a scene.

(2) Slide the “scene” icon to left, and then choose “Edit” scene

(3) Add Execution Task

(4) Choose “Device” and then select the shade you want to add to this scene

(5) Choose an “Action” for the shade you selected. Then Add to Siri.

(6) In the Add to Siri menu, you can edit the “Siri shortcut command”. For example: “open shade in bedroom”. After all tasks are set up, save the scene. Now you can let Siri control your shades.

## 7. Link to “Amazon Alexa” & “Google home” voice control device

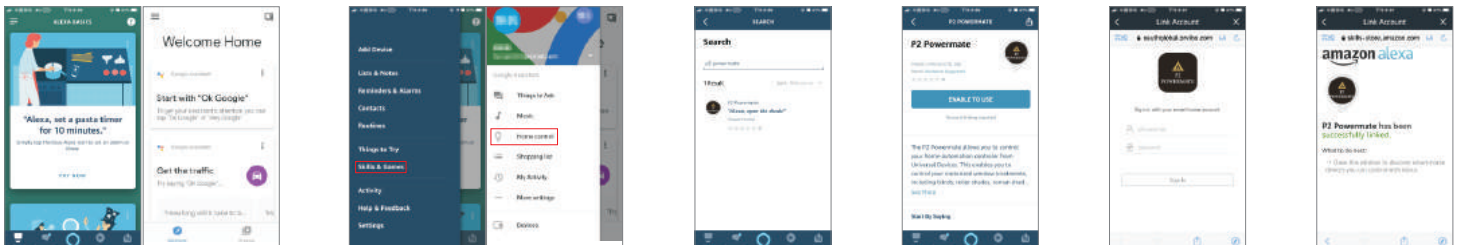

(1) Login in your “Amazon Alexa” or “Google home” APP

(2) “Amazon Alexa” add “Skills & Games” “Google Home” add “Home control”

(3) Search “p2 powermate”

(4) Choose “ENABLE TO USE”

(5) Input your “p2 powermate” account and password, then sign in. Now P2 Powermate had been linked to your “Alexa” or “Google Home” voice control device.

## Motorization Troubleshooting Guide

PROBLEM	SOLUTION
Shade moving in the wrong direction.	Reset the motor to factory spec and erase all limits, then program from the beginning.
Shade not stopping at desired height (reset limit).	Top limit can not be reset without erasing all limits and starting from the beginning. Take the shade to the incorrect limit, press and hold the program button on the back of the remote until the shade jogs. Move the shade to the desired height, then press and hold the program button until the shade jogs again. The limit has been reset
Motor has no response to remote.	Press and hold the program button on head of motor. See if it jogs. If it does, then walk through programming from beginning, Check the antenna, make sure it is not kinked or touching metal.
Still not working. Plug in the motor.	See if motor operates or can be programmed.
Switch motor to another channel.	If remote already has 1 motor on the desired channel, put that motor in sleep mode and then erase the memory of the motor that is to be switched and joined on another channel. Program the new channel and then wake the other motor up.
Motor begins to beep. Power is getting low.	Plug in the motor as soon as possible. If the power drops to zero voltage, the memory could be lost and the motor will have to be reprogrammed.



## SETUP CODE CODE DE CONFIGURATION

SBCAN

## Getting to know your Smart Controller

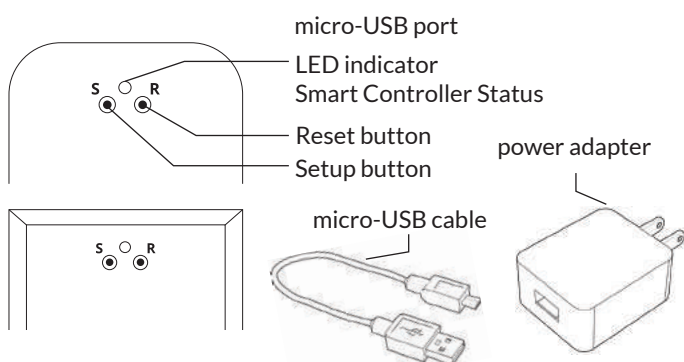

**Smart Controller Status:**  
Flashing blue - Hotspot available  
Flashing green - Connecting to the WiFi network  
Pulsing cyan/blue-green - Connected to the Internet

## Getting Started

- 1 Download the Neo Smart Blinds app**

Download the app to your phone or tablet by searching **Neo Smart Blinds** on Google Play or the App Store.  
**Note:** Do not install Neo Smart Blinds Blue
- 2 Plug in your Smart Controller in reach of your home WiFi**

Choose a place not too far from your home router or a place you know has good WiFi signal strength. You will be able to change its location after, if necessary.
- 3 Create an account and choose the setup code written on the cover**

After opening the app, tap on Create one to create a new account. Enter a valid email address and choose a password, select the region time zone from the place where the Smart Controller will be located. Choose the setup code written in the cover and tap on Register.
- 4 Follow the app step by step to add the Smart Controller**

Have in hand the home WiFi password. It will be necessary to connect the Smart Controller to the Internet.  
**Note:** Some Android users won't be connected quickly to the hotspot. If it is the case, please wait about 10 seconds before returning to the app. During this time, your device may notify you that the hotspot does not have Internet access, and will prompt you whether you want to remain connected. You need to select the option that will allow you to keep connected before returning to the app.

## System requirements

- A strong WiFi signal (3 bars or more) in the location where you will setup your Smart Controller.
- The Smart Controller only supports 2.4GHz WiFi (IEEE 802.11b/g/n), not 5GHz. WiFi security needs to be set to WPA-PSK or WPA2-PSK.
- A smartphone or tablet running Android 5.0 (Lollipop) or higher, or iOS 8 or higher is needed.

## Troubleshooting

### The home WiFi doesn't appear in the step 4

Try rescanning, if the problem persists, you will need to reposition the Smart Controller to a place with stronger WiFi signal. In this case, exit the process (tap on the menu, then tap Your Rooms), replace the Smart Controller and start over.

### The Smart Controller LED in the bottom is not blinking blue

#### The process fails in the last step

Press the S button for 10 seconds, then press the R button once and start over. Pay special attention when typing the WiFi password.

## Need more help?

Visit [neosmartblinds.com/smartcontroller](http://neosmartblinds.com/smartcontroller) for detailed instructions about how to use the app and troubleshooting.

## Integrations

### Smart home devices

Visit [neosmartblinds.com/smartcontroller-integrations](http://neosmartblinds.com/smartcontroller-integrations) for detailed information about connecting to Amazon Alexa, Google Home and other systems.

### Control4

Please send an email to [tech@neosmartblinds.com](mailto:tech@neosmartblinds.com) with your name, your email and your company's name. This information is necessary to always send to you any further driver update.

### Legal Information

#### FCC

This equipment has been tested and found to comply with the limits for a Class B digital device, pursuant to Part 15 of the FCC Rules. These limits are designed to provide reasonable protection against harmful interference in a residential installation. This equipment generates uses and can radiate radio frequency energy and, if not installed and used in accordance with the instructions, may cause harmful interference to radio communications. However, there is no guarantee that interference will not occur in a particular installation. If this equipment does cause harmful interference to radio or television reception, which can be determined by turning the equipment off and on, the user is encouraged to try to correct the interference by one of the following measures:

- Reorient or relocate the receiving antenna.
- Increase the separation between the equipment and receiver.
- Connect the equipment into an outlet on a circuit different from that to which the receiver is connected.
- Consult the dealer or an experienced radio/TV technician for help

#### Contains transmitter module FCC ID: COFWNMNB11

To comply with FCC/IC RF exposure limits for general population/ uncontrolled exposure, the antenna(s) used for this transmitter must be installed to provide a separation distance of at least 20 cm from all persons and must not be co-located or operating in conjunction with any other antenna or transmitter.

#### IC

This device complies with Industry Canada's licence-exempt RSSs. Operation is subject to the following two conditions:

- This device may not cause interference; and
- This device must accept any interference, including interference that may cause undesired operation of the device.

This device meets the exemption from the routine evaluation limits in section 2.5 of RSS102 and users can obtain Canadian information on RF exposure and compliance.

#### Contains transmitter module IC: 10293A-WMNB11

This End equipment should be installed and operated with a minimum distance of 20 centimeters between the radiator and your body.

